

Unpacking

Before you begin using the device, please check the version you got and ensure that the following items are included in the shipped box:

Universal Accessories:

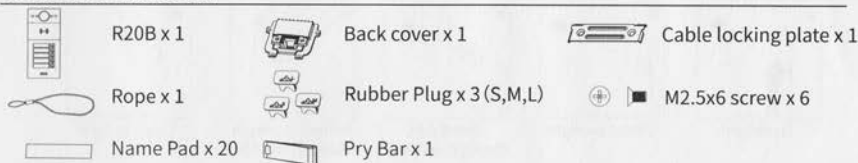

Wall-mounting Accessories :

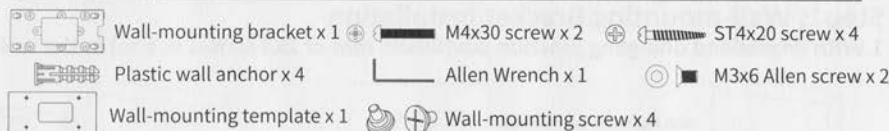

Product Overview



Installation Environment

Indoor and outdoor installation are supported.

If installing the device outdoors, please don't place device under direct sunlight, it will bring a bad effect or be broken with the high temperature.

If installing the device indoors, please keep device at least 2 meters away from light, and at least 3 meters away from window and door.



Backlight

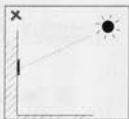

Direct sunlight

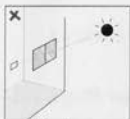

Direct sun through window



Indirect sunlight through window



Close to light

Wall-mounting Installation

Step1: Wall-mounting Bracket Installation

1. With embedded one-gang junction box (86x86 mm or 2x3 inches in size) in the wall.

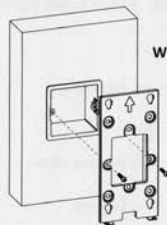

With 86x86 mm junction box.

Fix the wall-mounting bracket on 86x86 mm junction box with two M4x30 screws.

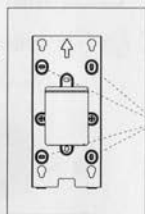

Mark the four holes of the wall-mounting bracket on the wall.

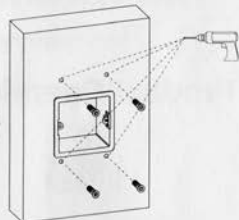

Drill (5 mm drill bit required) the four marked fixing holes on the wall with a depth of 25 mm. Then insert four plastic wall anchors.

or

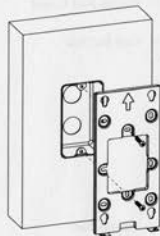

With 2x3 inches junction box

Fix the wall-mounting bracket to the 2x3 inches junction box with two M4x30 screws.

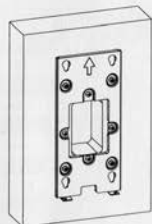

Finish the wall-mounting bracket installation.

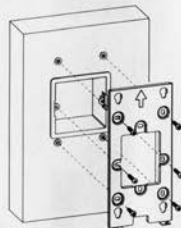

Tighten the wall-mounting bracket on the wall and junction box using four ST4x20 screws and two M4x30 screws.

2. Without embedded junction box in the wall

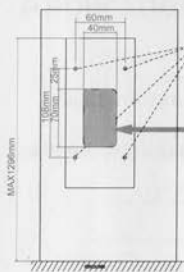

According to the wall-mounting template, drill (5 mm drill bit required) four screw holes with a depth of 25 mm and cut a rectangular hole on the wall with the diameter of 40x70 mm and depth of 40 that can accommodate and through out all necessary cables.

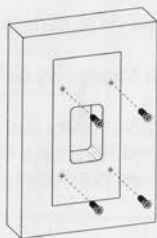

Insert four plastic wall anchors into the holes.

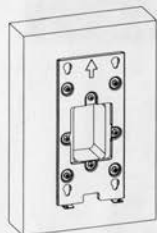

Finish the wall-mounting bracket installation.

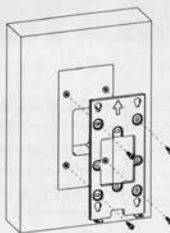

Tighten the wall-mounting bracket on the wall using four ST4x20 screws.

Step2: Back Cover Installation

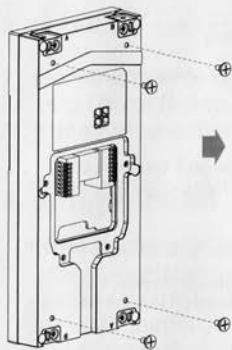

Install 4 wall-mounting screws to the back of device.

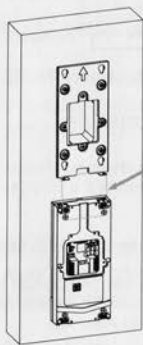

For convenient wiring, hang R20K on the wall-mounting bracket with rope.

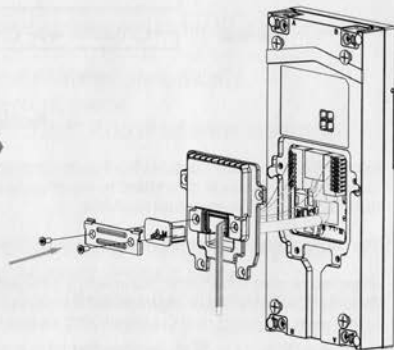

Make cables go through the back cover, connecting to the corresponding interfaces of the main board. Select a suitable size rubber plug to push all the cables into the back cover. Fix cable locking plate to the back cover with two M2.5x6 screws.

wall-mounting screws

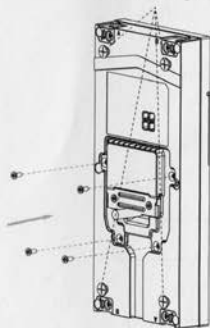

Fasten the back cover with four M2.5x6 screws.

wall-mounting screws holes

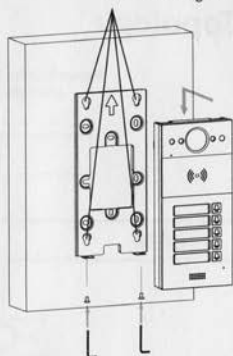

Insert the four wall-mounting screws on the device into the corresponding holes on the wall-mounting bracket, and then press down to slide the wall-mounting screws into the groove. Then use the Allen Wrench to tighten the device with two M3x6 screws.

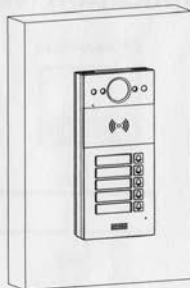

Installation completed.

Installation Tips

Open the name pad cover with a pry bar, put the filled-in name pad in the name pad cover, and put back to close it.

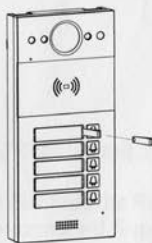

Device Wiring

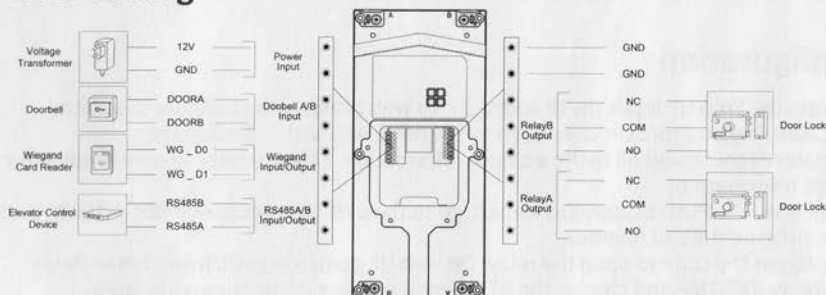

Application Network Topology

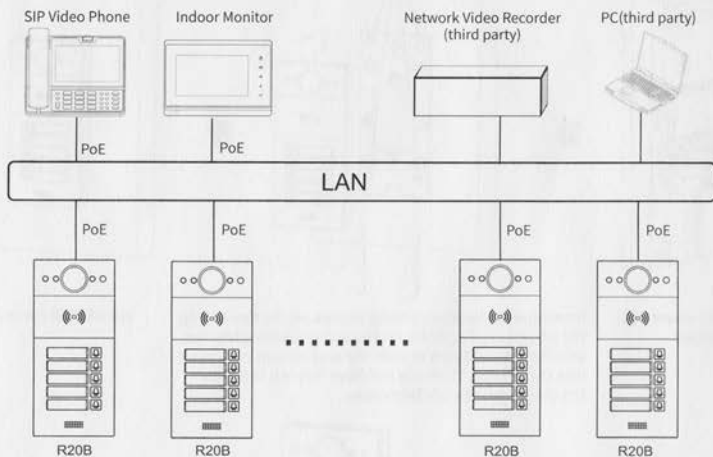

IP Announcement

1. While R20B starts up normally, press *3258*, voice system will enter IP announcement mode.
2. In announcement mode, the IP address will be announced periodically.
3. Press Cancel Button again to quit the announcement mode.
4. In announcement mode, phone announces "IP 0.0.0.0" if no IP address is gained.

Configuration

1. Access the Web UI: Input the IP address into web browser to configure the phone.
2. Account Registration: On web UI, go to the path: Account -> Basic page Register Account and fill in the account information. (Please refer to user manual for more information)
3. Configure the Push Button: On web UI, go to the path: Intercom -> Basic -> Push Button to configure the call number.
4. Configure the code to open the relay: On web UI, go to the path: Intercom -> Relay -> Relay ID/DTMF and choose the DTMF code number in corresponding area.

Operation

Make a call:

Press the SIP number or IP address and dial key to make a call.

Receive a call:













R20B supports Auto Answer by default. Incoming call will be answered automatically.

Unlock:

1. During the talk, called party can press pre-configured code number to unlock the door;
2. Scan the predefined RFID card nearby the card reader to unlock;
3. Press the predefined pin code to unlock.

Indicators

 Light ON  Light OFF

Name	Status	Description
Status indicator	Blue	 Normal status
	Red	 0.25sec →  0.25sec
		 0.05sec →  0.05sec
	Green	 0.25sec →  0.25sec
		 Initialing/Talking on a call
	Red/Blue	 0.25sec →  0.25sec
	 0.05sec →  0.05sec	

Note: For more LED settings, please refer to R20B webUI: Intercom -> LED Setting.

Notice Information

Akuvox R20B firmware contains third-party open source software under the terms of the GNU General Public License (GPL). Akuvox is committed to meeting the requirements of the GNU General Public License (GPL) and will make all required source code available.

The source code of software under the terms of GNU GPL can be downloaded online: <http://www.akuvox.com/gpl>.

Information contained in this document is believed to be accurate and reliable at the time of printing. This document is subject to change without notice, any update to this document can be viewed on Akuvox's website: <http://www.akuvox.com> © Copyright 2020 Akuvox Ltd. All rights reserved.



AKUVOX (XIAMEN) NETWORKS CO., LTD.
 ADD: 10/F, NO.56 GUANRI ROAD, SOFTWARE PARK II, XIAMEN 361009, CHINA
www.akuvox.com



YS20000058